

les éditions **easyJet**

NOT- ICE DE PLIA- GE

01

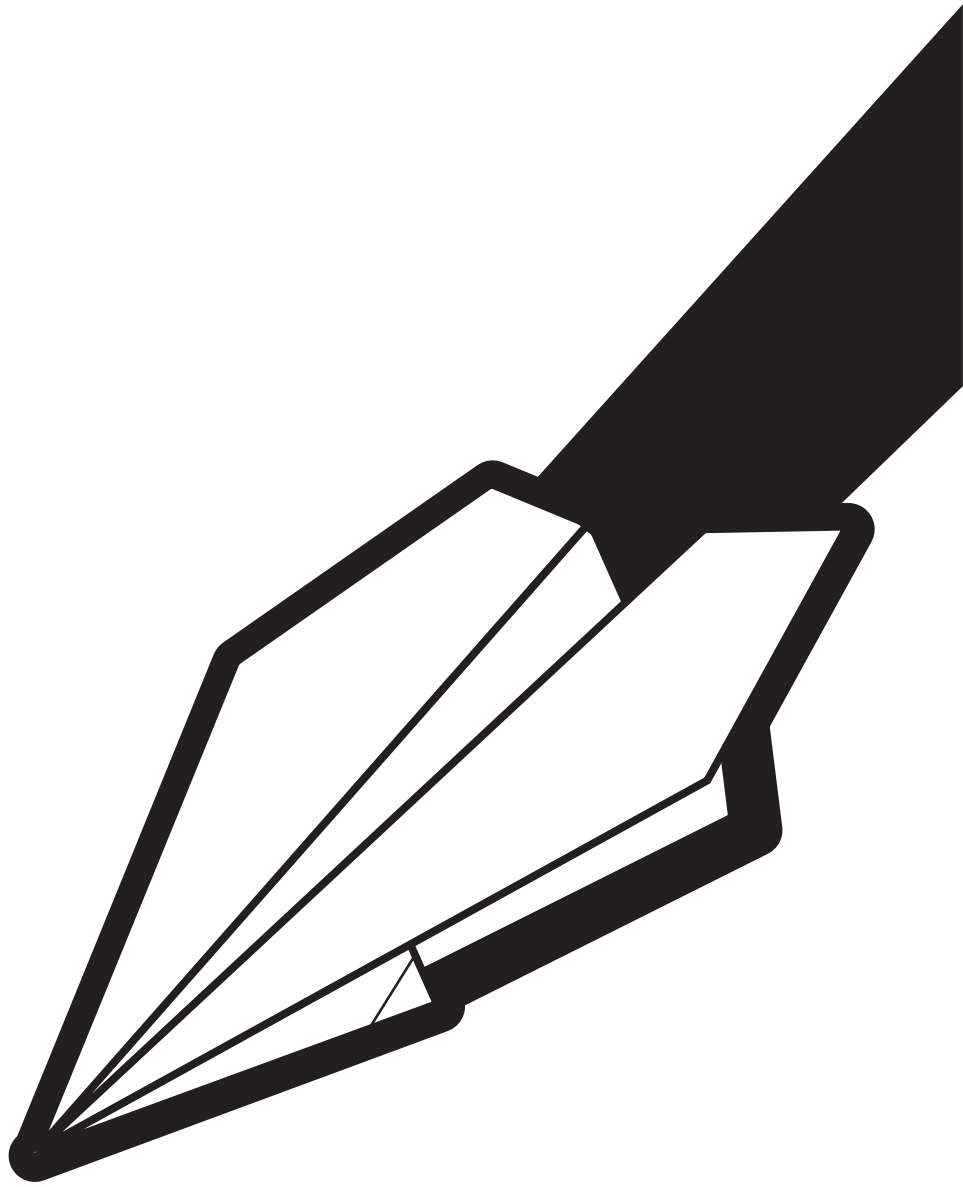

LE

PIOUPIOU

DU DÉSERT

niveau de difficulté : un poussin de trois jours, 2h00, 36mn et 12s

01

LE PLOUPIOU DU DÉSERT

Niveau de difficulté : un poussin de trois mois

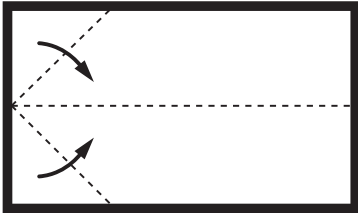

01 Préparez le pliage central de la feuille ainsi que celui des coins.

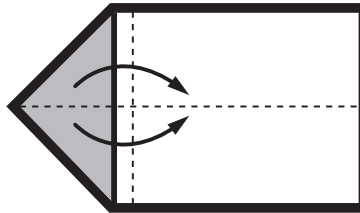

02 Rabattez les angles.

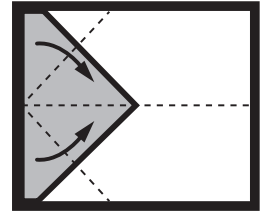

03 Pliez les angles une nouvelle fois.

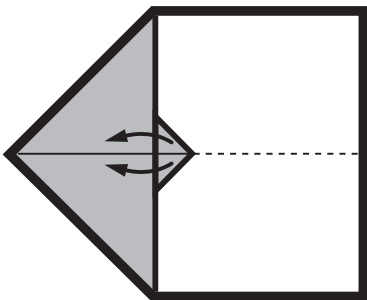

04 Rabattez la pointe.

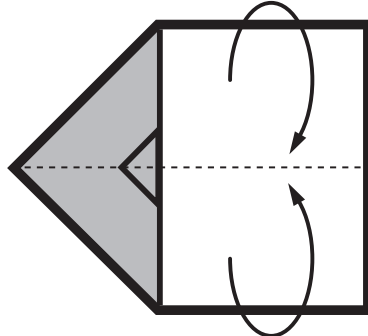

05 Pliez l'avion en deux.

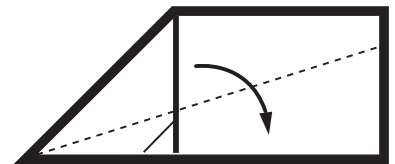

06 Pliez les ailes.

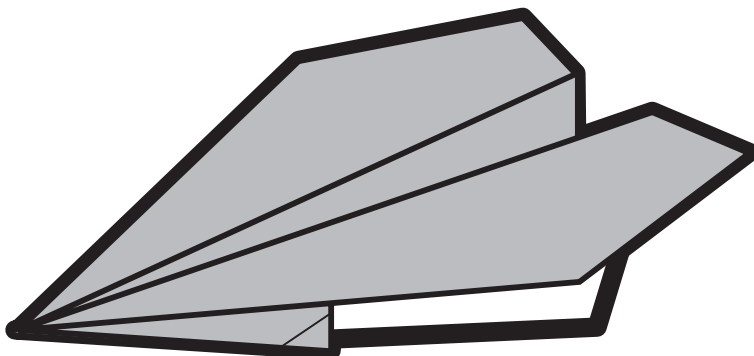

07 Bravo ! Vous n'avez plus qu'à l'envoyer à votre meilleur ami.

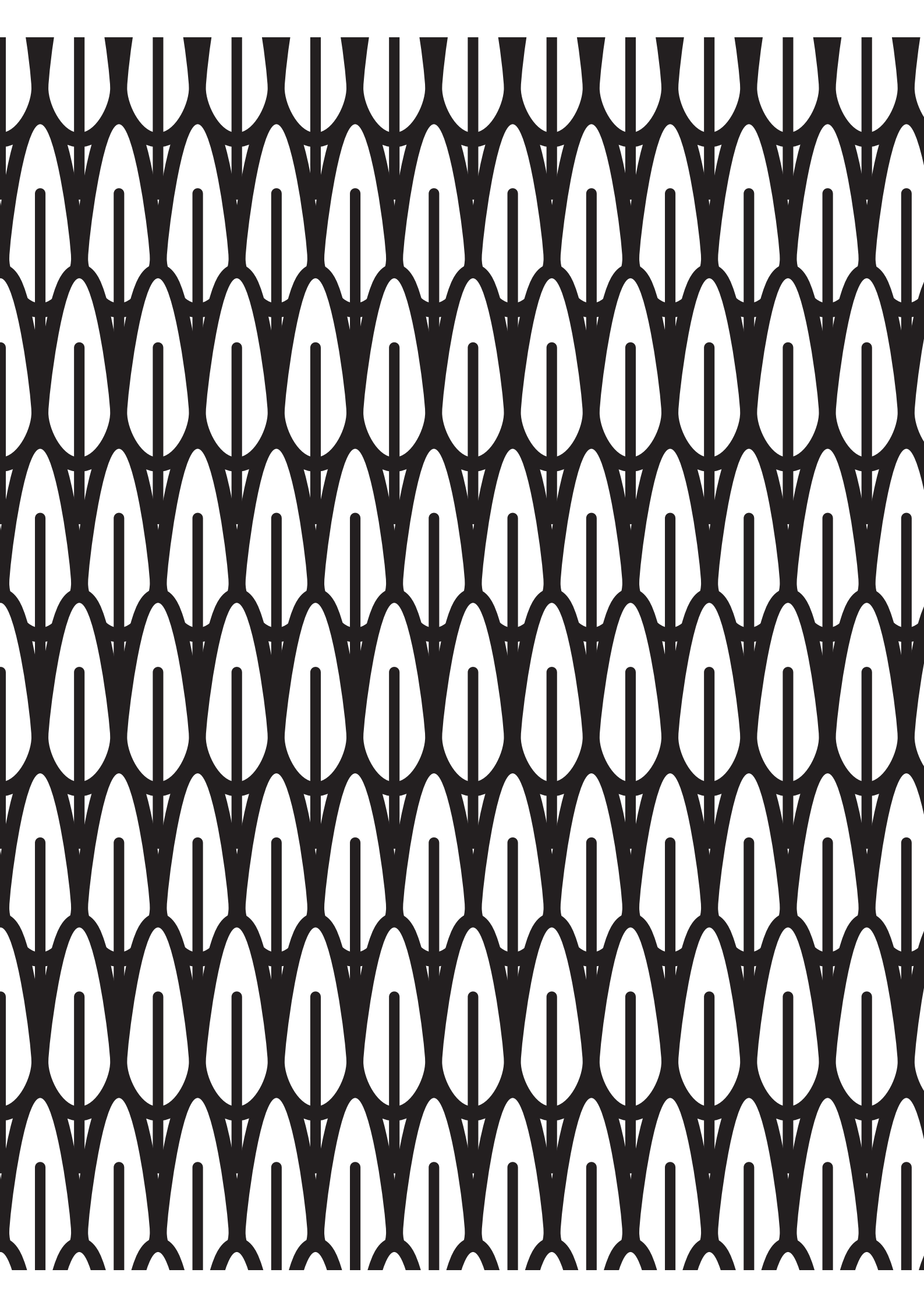

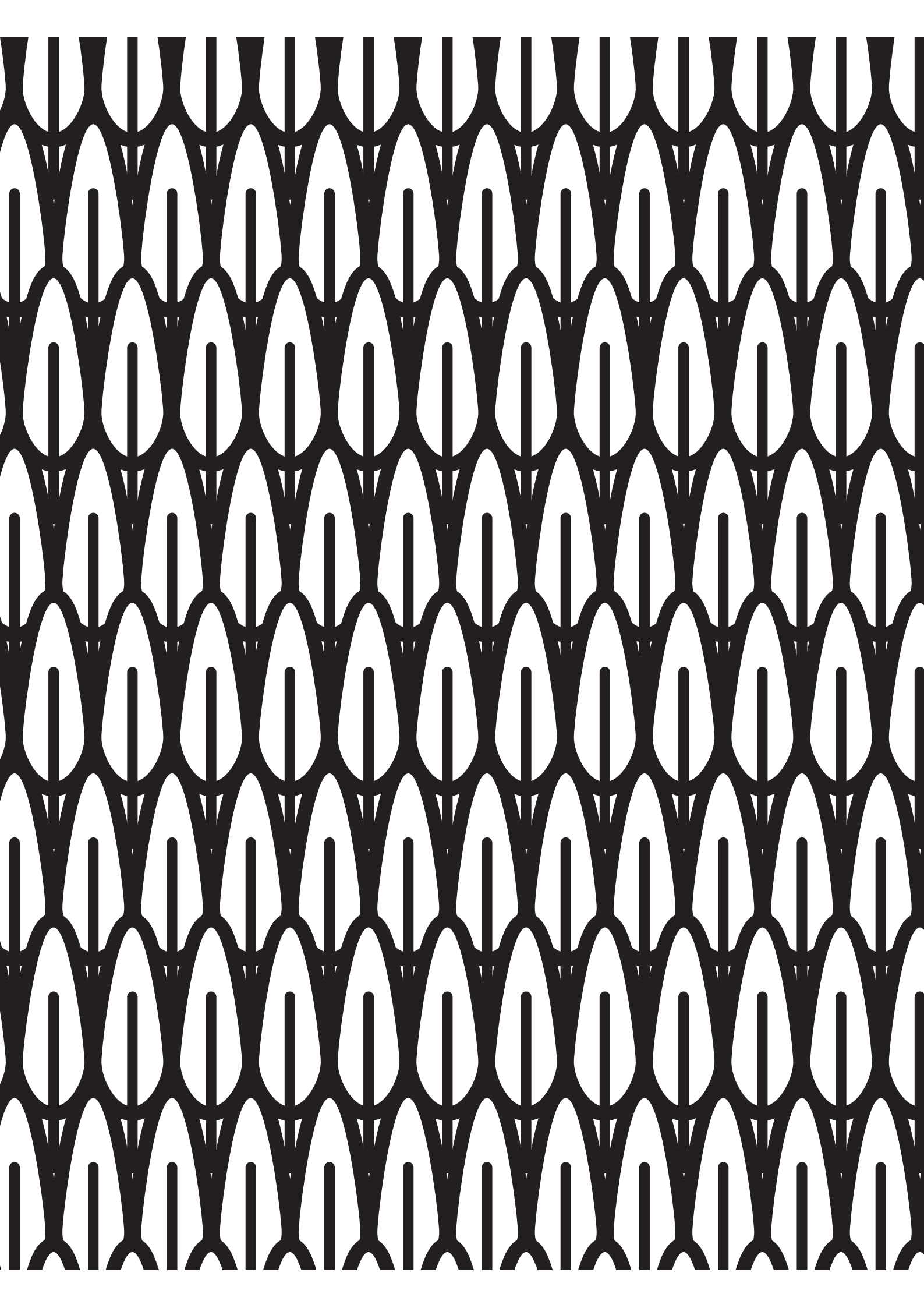

02

LE
MIROR

niveau de difficulté : pour les penseurs
et réflexologues avertis

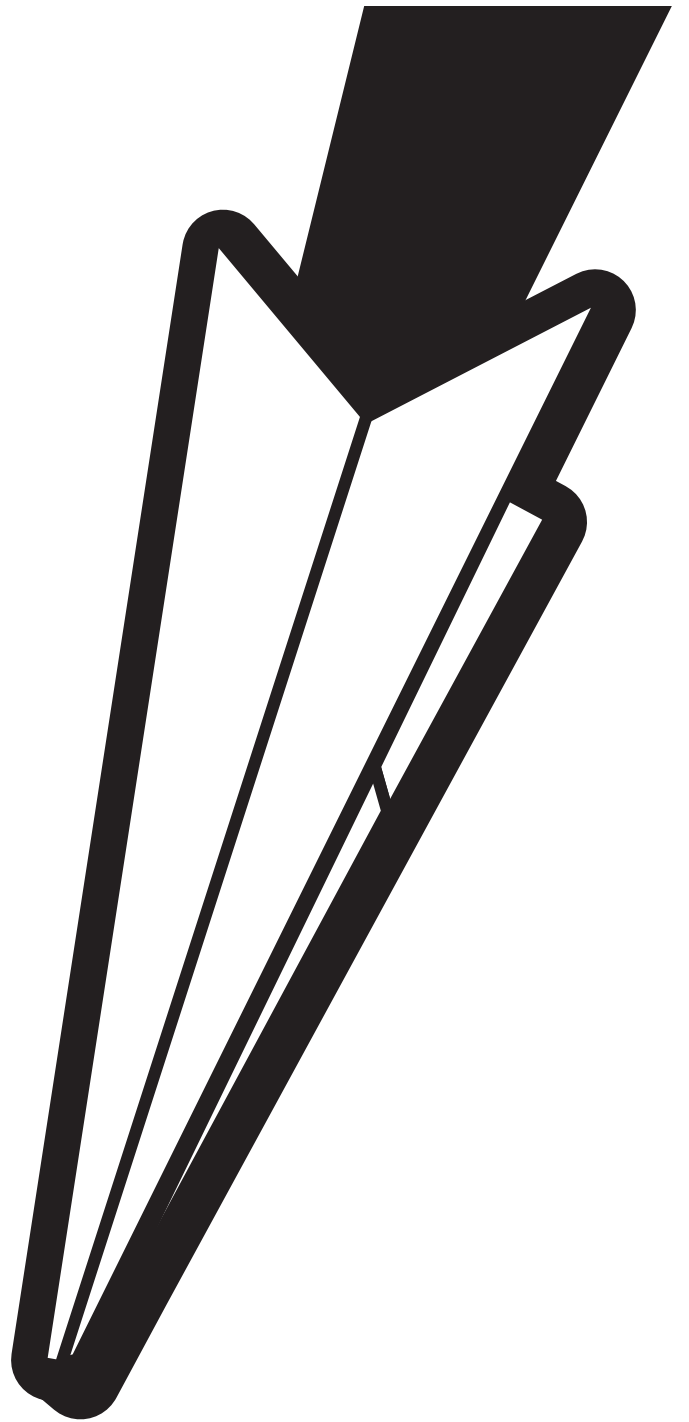

07 pliez les angles qui forment le nez et laissez partir votre avion.

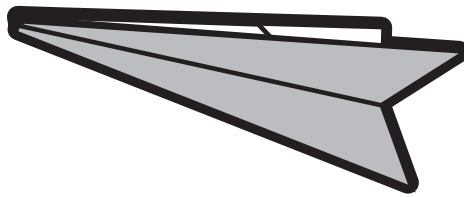

08 un parcours... Je relâche et plante plus du 9 à droite. Bravo ! Vous n'avez

04 dans le bon sens. Rabattez le bec

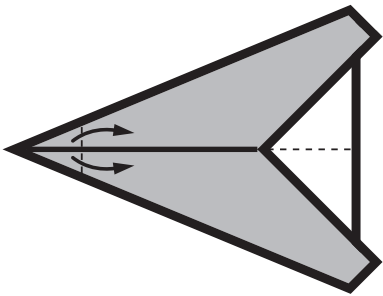

02 et pliez l'avion en 2 parties complètes. Pliez garde aux

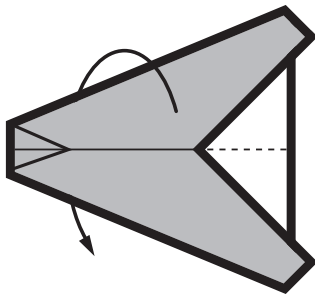

06 pliez les angles. Ne réfléchissez pas,

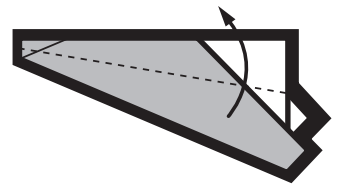

01 la feuille en deux. Tracez le pli et pliez

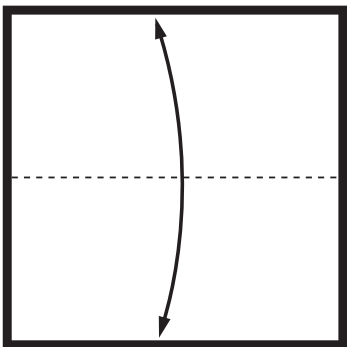

05 et pliez les angles. Observez votre reflet

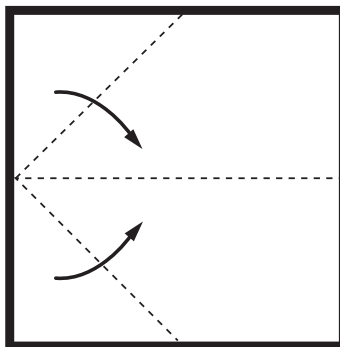

03 les une seconde fois les angles et pliez faites l'autre.

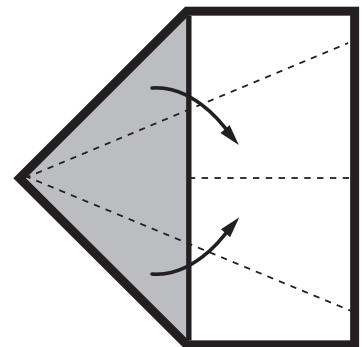

Niveau de difficulté : pour les penseurs et réfléchologues avertis

*Aucun lien de parenté ne saurait être fait avec une marque existante.

LE MIROR*

02

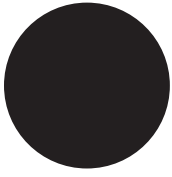

Ici

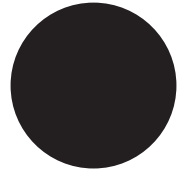

Là (Attention,
collez bien droit)

**COLLEZ
UN MIROIR**

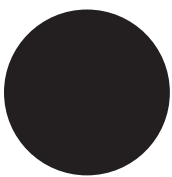

Ici aussi

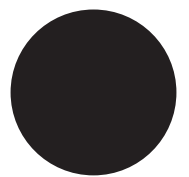

Voilà,
c'est presque fini



Et hop !
On recommence



Là encore
(Ne dépassez
pas ; ça ne
va pas faire joli)

ET OUI, IL Y A L'AUTRE CÔTÉ



Et puis ici

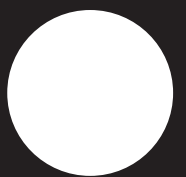

Voilà, maintenant c'est vraiment fini
(N'oubliez de regarder comme vous êtes beau)

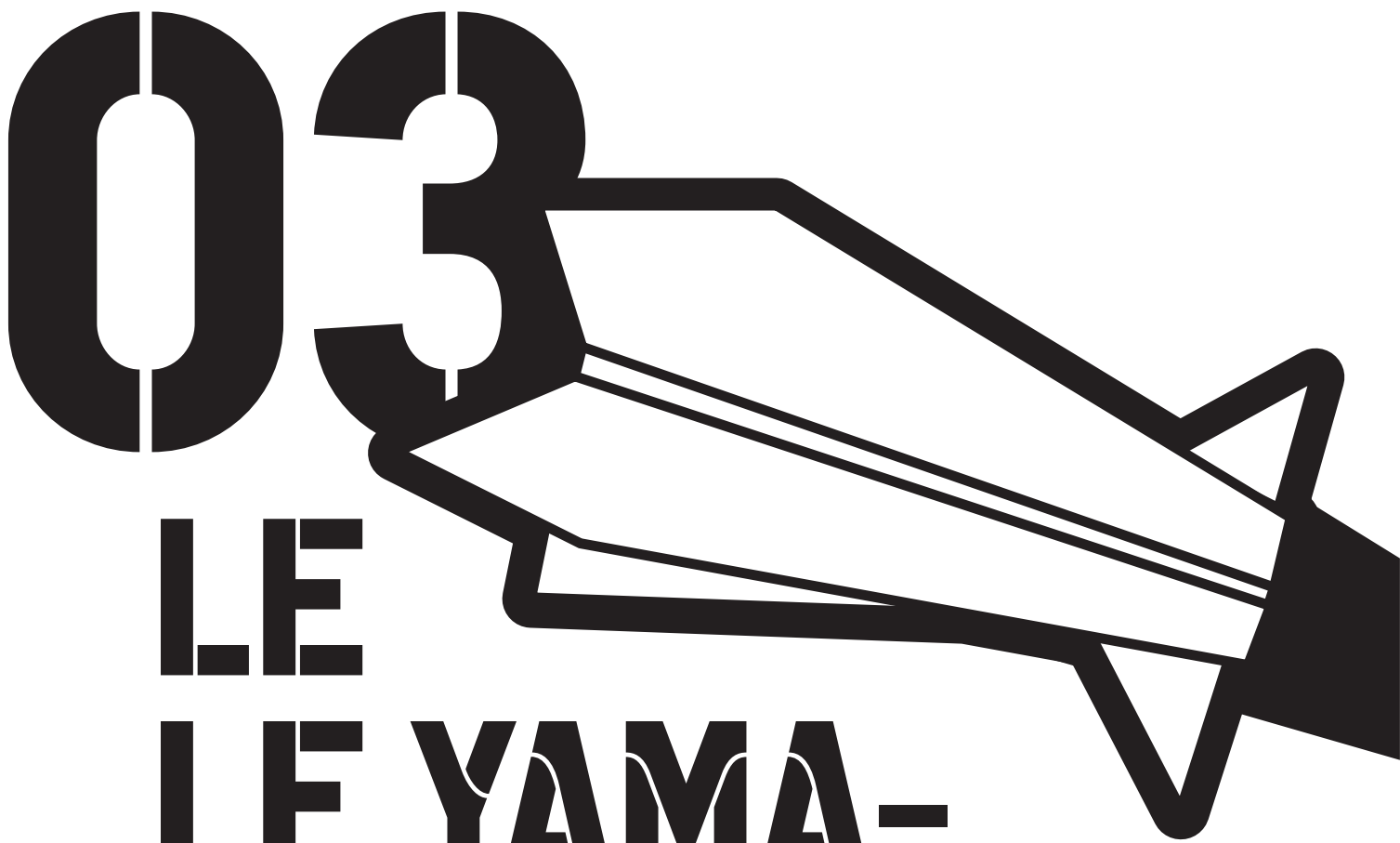

**LE
LE YAMA-
MOTOR**

niveau de difficulté : pour les kin-boshi

03

LE YAMAMOTOR

Niveau de difficulté : pour les kin-boshi

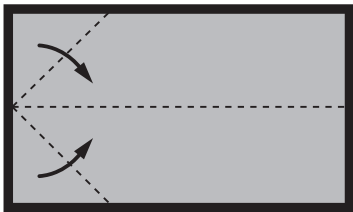

01 ニつ折りにする

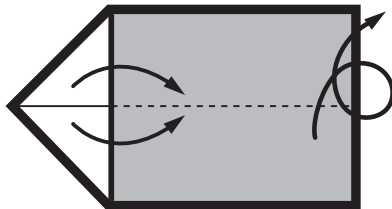

02 バックアップを折る

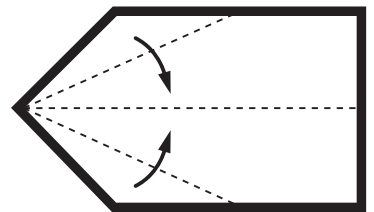

03 超クールなしかし、方法改善のひだ

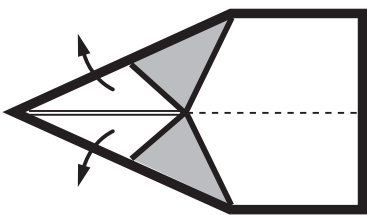

04 パンを食べる

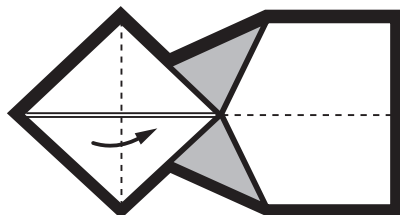

05 昨日、私は薬と呼ばれる

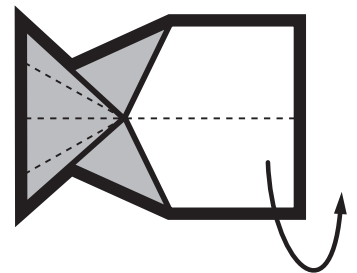

06 彼らイージージェットでクールだ

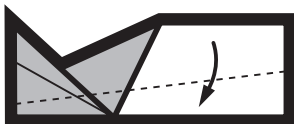

07 非常に理解していない、そこが

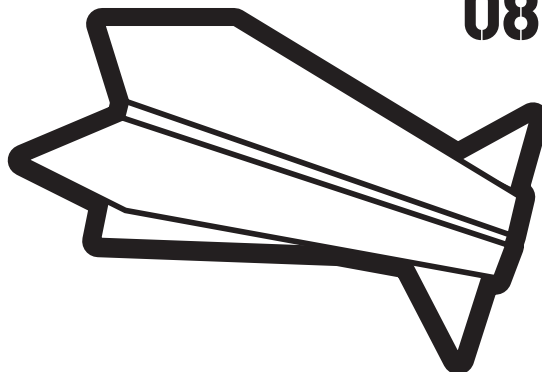

08 美しい!





04



LE DICO-
TYLÉDONE
VOLANT

niveau de difficulté : pour les cordons bleus

04

LE DICOTYLÉDONE VOLANT

Niveau de difficulté : pour les cordons bleus

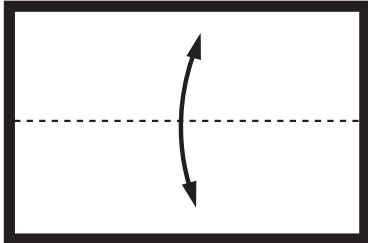

01 Épluchez et coupez finement les oignons.

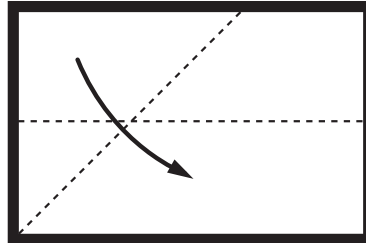

02 Faites les revenir à feu doux.

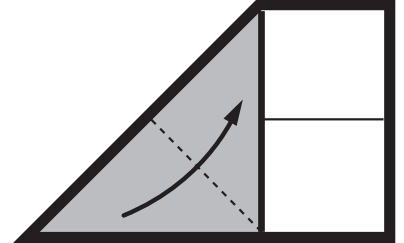

03 Ajoutez les rondelles de courgettes.

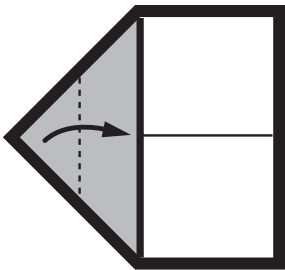

04 Mélangez doucement.

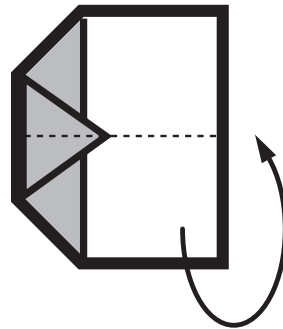

05 Ajoutez les champignons

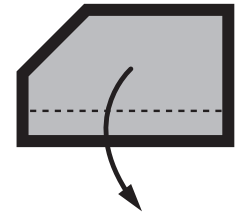

06 Salez et poivrez

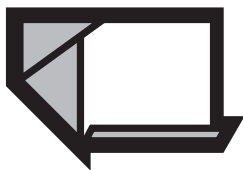

07 Versez un ½ verre de vin blanc

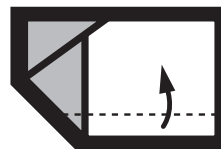

08 Laissez mijoter

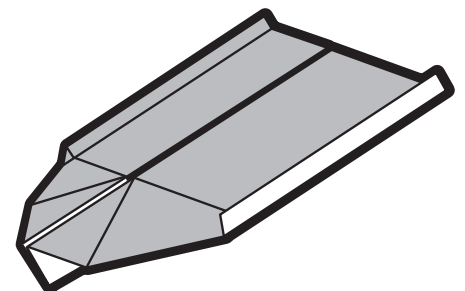

09 Juste avant de servir, ajoutez l'ail et le persil finement haché.

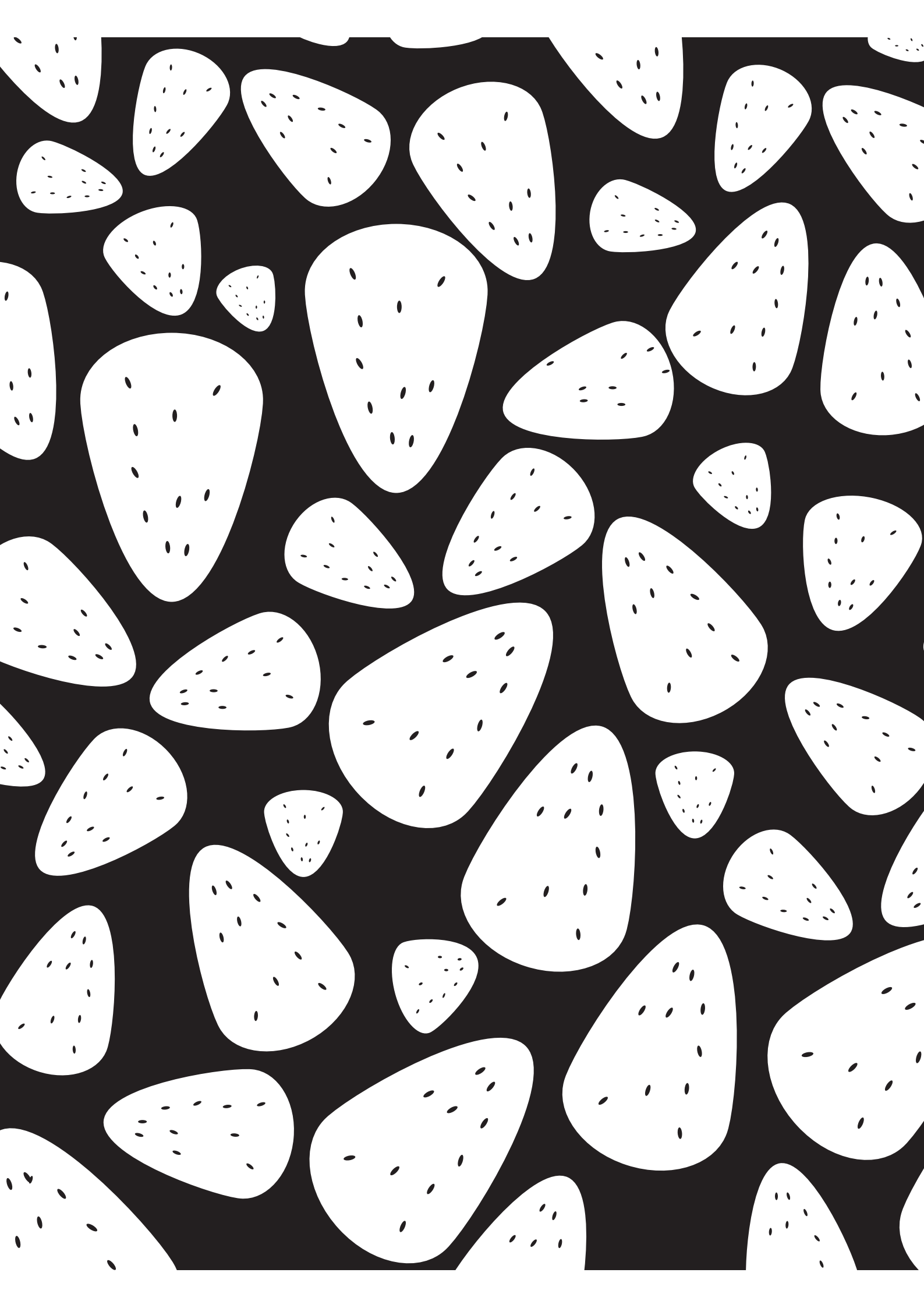

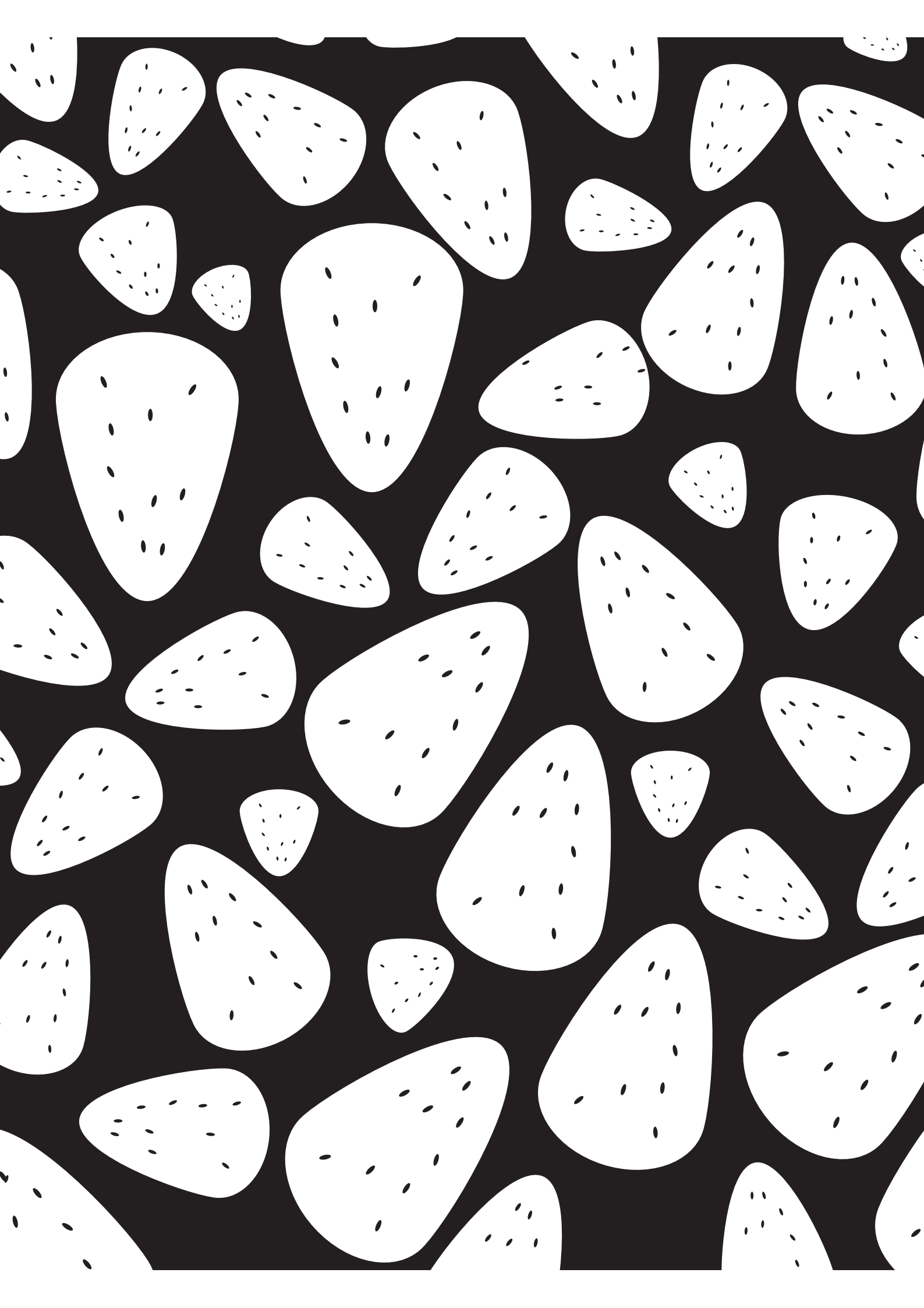

05

LE

NEWTON

niveau de difficulté : pour les matheux à lunettes



05

LE NEWTON

Niveau de difficulté : pour les matheux à lunettes

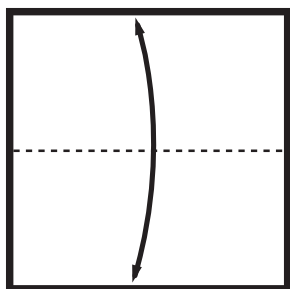

01 si $4n + 3$ est un carré parfait

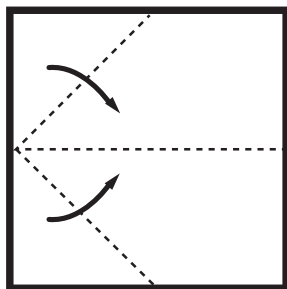

02 , $\exists k \approx \Delta$ tel que $4n+3 = k^2$

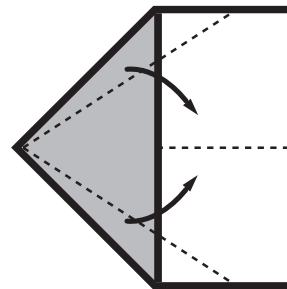

03 $n = (k^2-3)/4 = (k/2)^2 - 3/4$

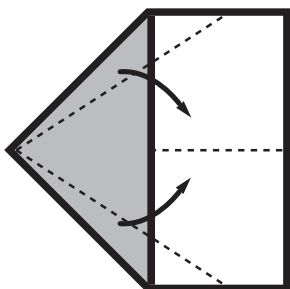

04 si k est pair, $k/2$ est entier et son carré aussi

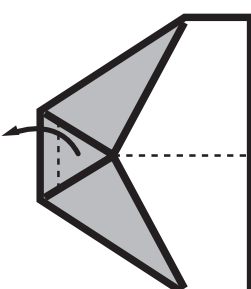

05 si k est impair $(k/2)$ est de la forme $N + 1/2$ et son carré de la forme $N^2 + N + 1/4$

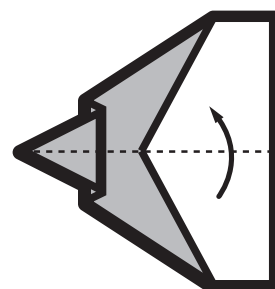

06 or $1/4 - 3/4$ ne sera jamais entier

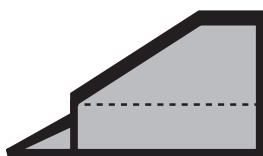

07 Donc, un carré est congru à 0 ou 1 modulo 4

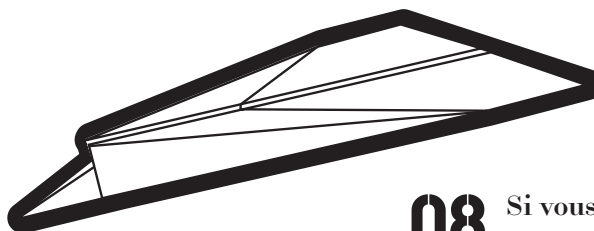

08 Si vous n'avez pas compris, recommencez encore une fois !

06



L' AVIA-
TEUR

ACOUSTIQUE

niveau de difficulté : Pour ceux qui ont l'oreille musicale

06

L'AVIATEUR ACOUSTIQUE

Niveau de difficulté : pour ceux qui ont l'oreille musicale

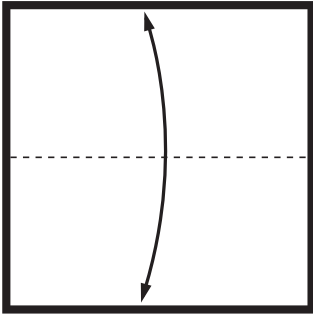

01

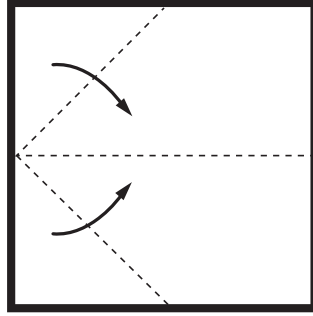

02

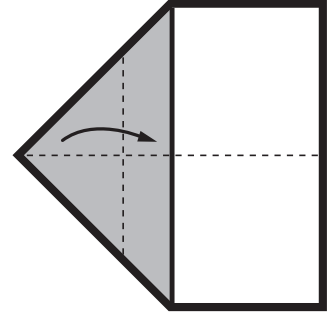

03

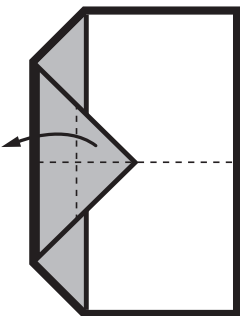

04

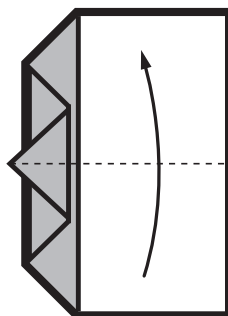

05

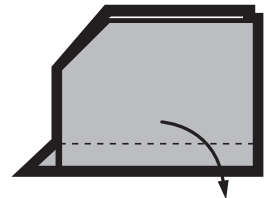

06



07



[REDACTED]

[REDACTED]

[REDACTED]

[REDACTED]

[REDACTED]

[REDACTED]

[REDACTED]

[REDACTED]

[REDACTED]

[REDACTED]

[REDACTED]

[REDACTED]

[REDACTED]

[Redacted]

[Redacted]

[Redacted]

[Redacted]

[Redacted]

[Redacted]

[Redacted]

[Redacted]

[Redacted]

[Redacted]

[Redacted]

[Redacted]

[Redacted]

[Redacted]

[Redacted]

[Redacted]

[Redacted]

07

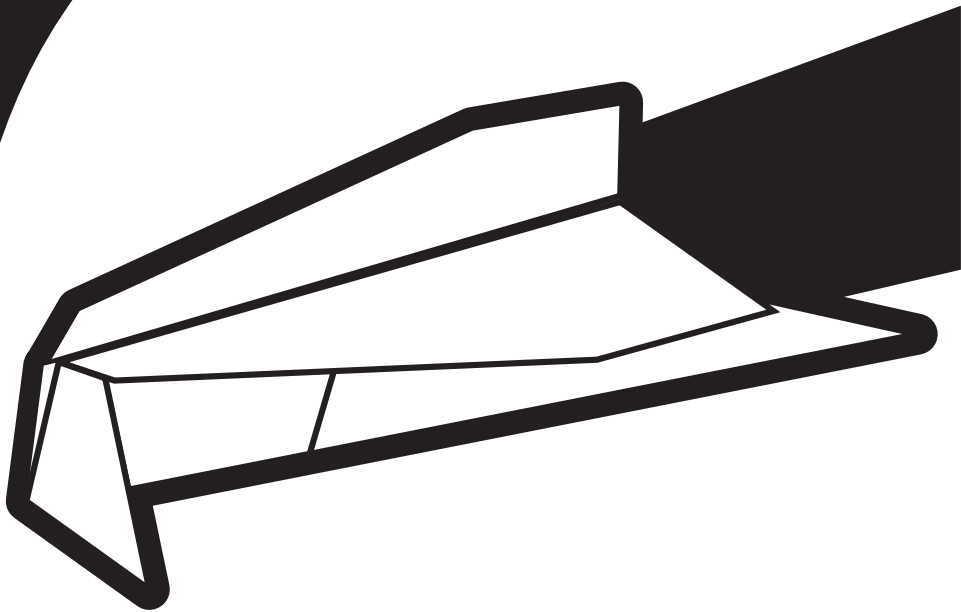

LE

MIRAGE

niveau de difficulté : pour les apprentis hypnotiseurs

07

LE MIRAGE

Niveau de difficulté : pour les apprentis hypnotiseurs

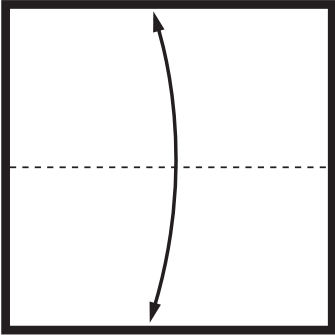

01 Concentrez-vous.

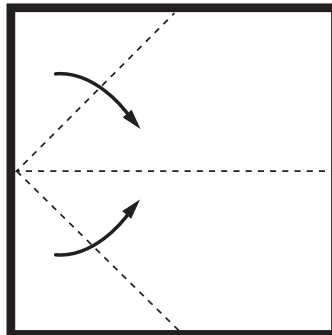

02 Fixez les points.

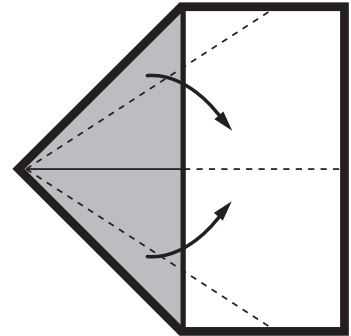

03 Plissez les yeux.

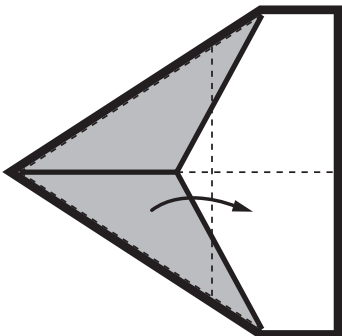

04 Louchez de l'œil droit.

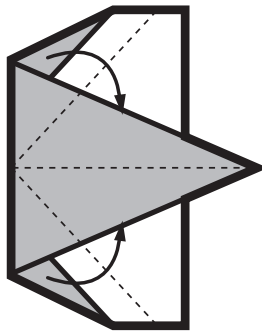

05 Louchez de l'œil gauche.

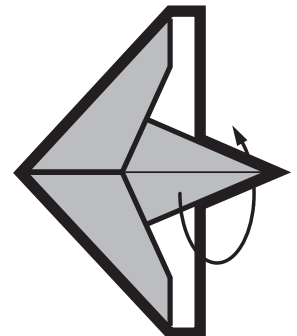

06 Faites converger vos iris.

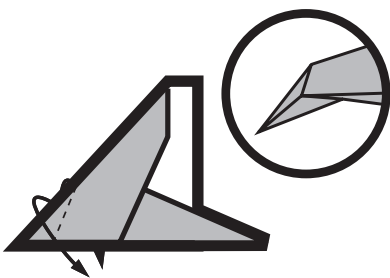

07 Plissez de nouveau les yeux.

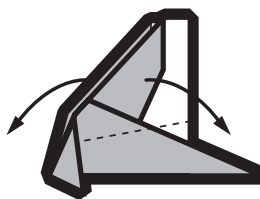

08 Massez-vous doucement les tympans.

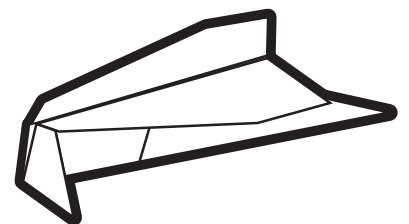

09 Bravo, vous n'avez plus qu'à prendre une aspirine contre les maux de tête !

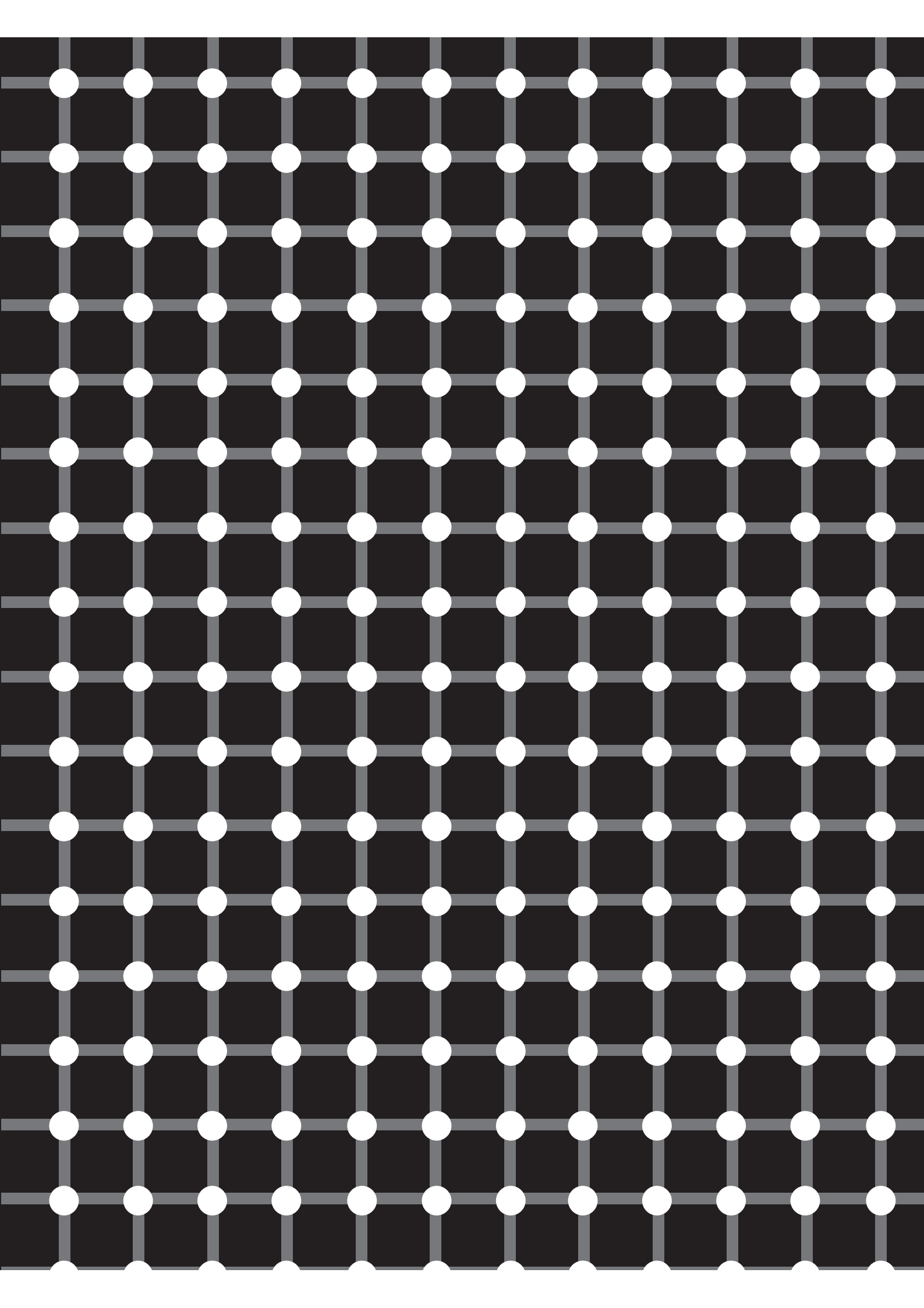

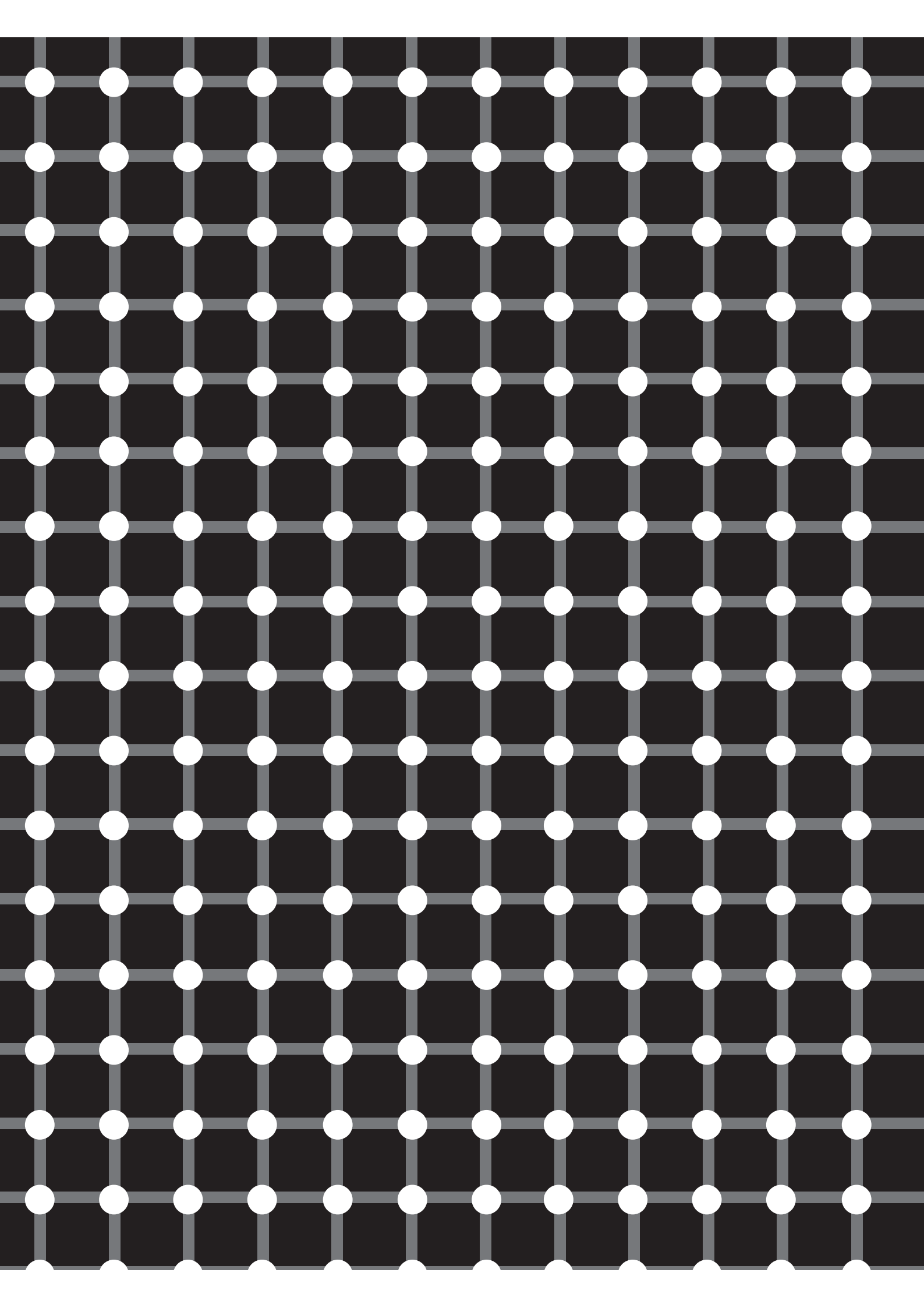

08

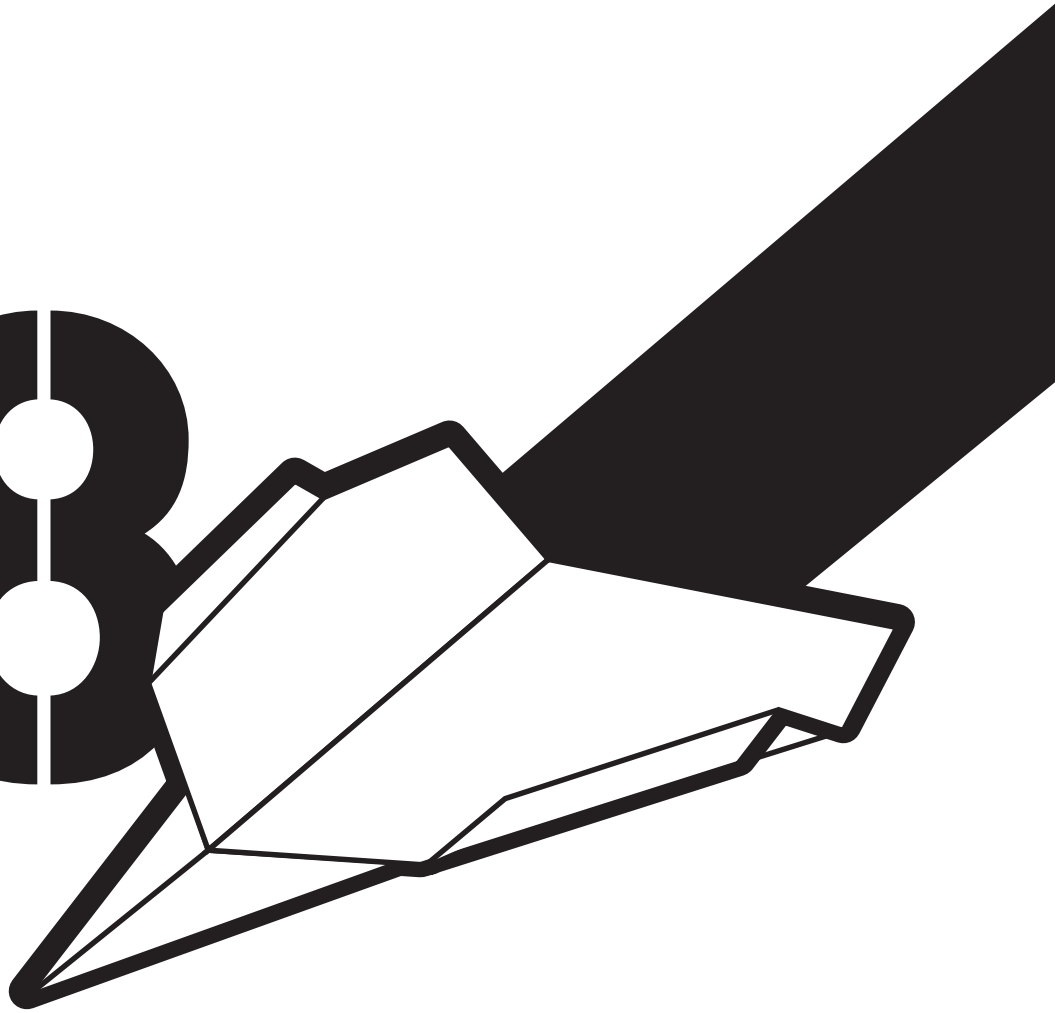

LE
BRISE
FER

niveau de difficulté : pour les experts en légo et mécano

08

LE BRISE FER

Niveau de difficulté : pour les experts en légo et mécanos

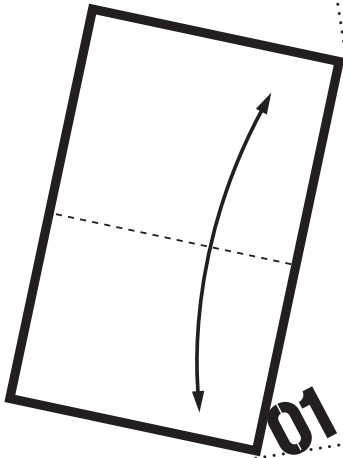

01

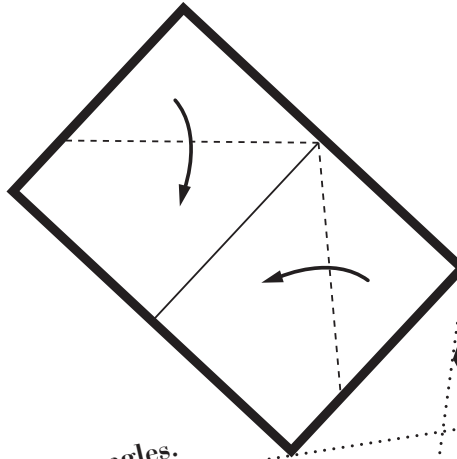

02 Rabattez les angles.

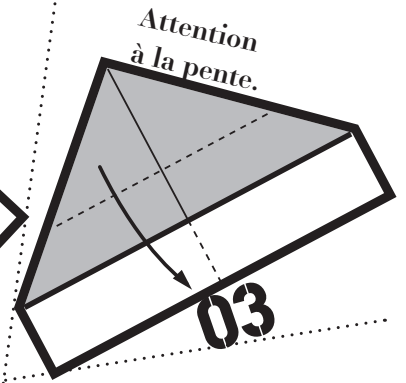

03

Préparez le pliage central de la feuille ainsi que celui des coins.

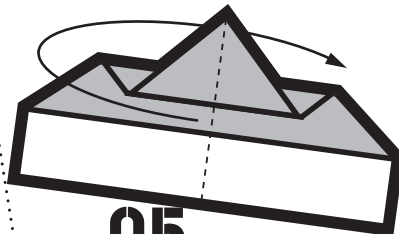

05

Pliez l'avion en deux.

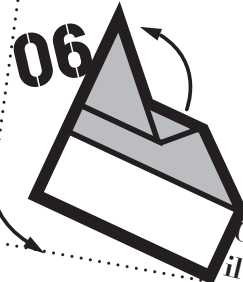

06

Oups, il va tomber.

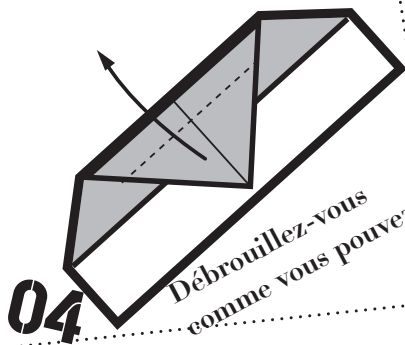

04

Débrouillez-vous comme vous pouvez.

Verglas fréquent.

08

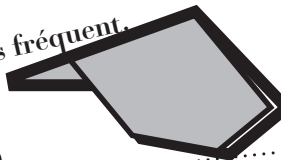

09

Be careful, une pente peut en cacher une autre.

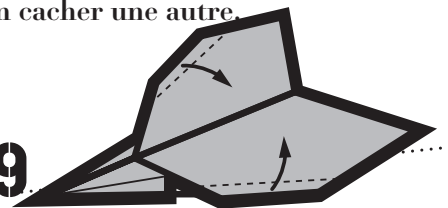

Aïeaaaa! Il est tombé.

07

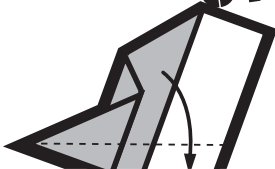

Bravo ! Vous n'avez plus qu'à reconstruire cette page.

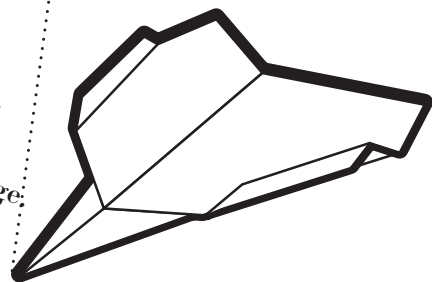

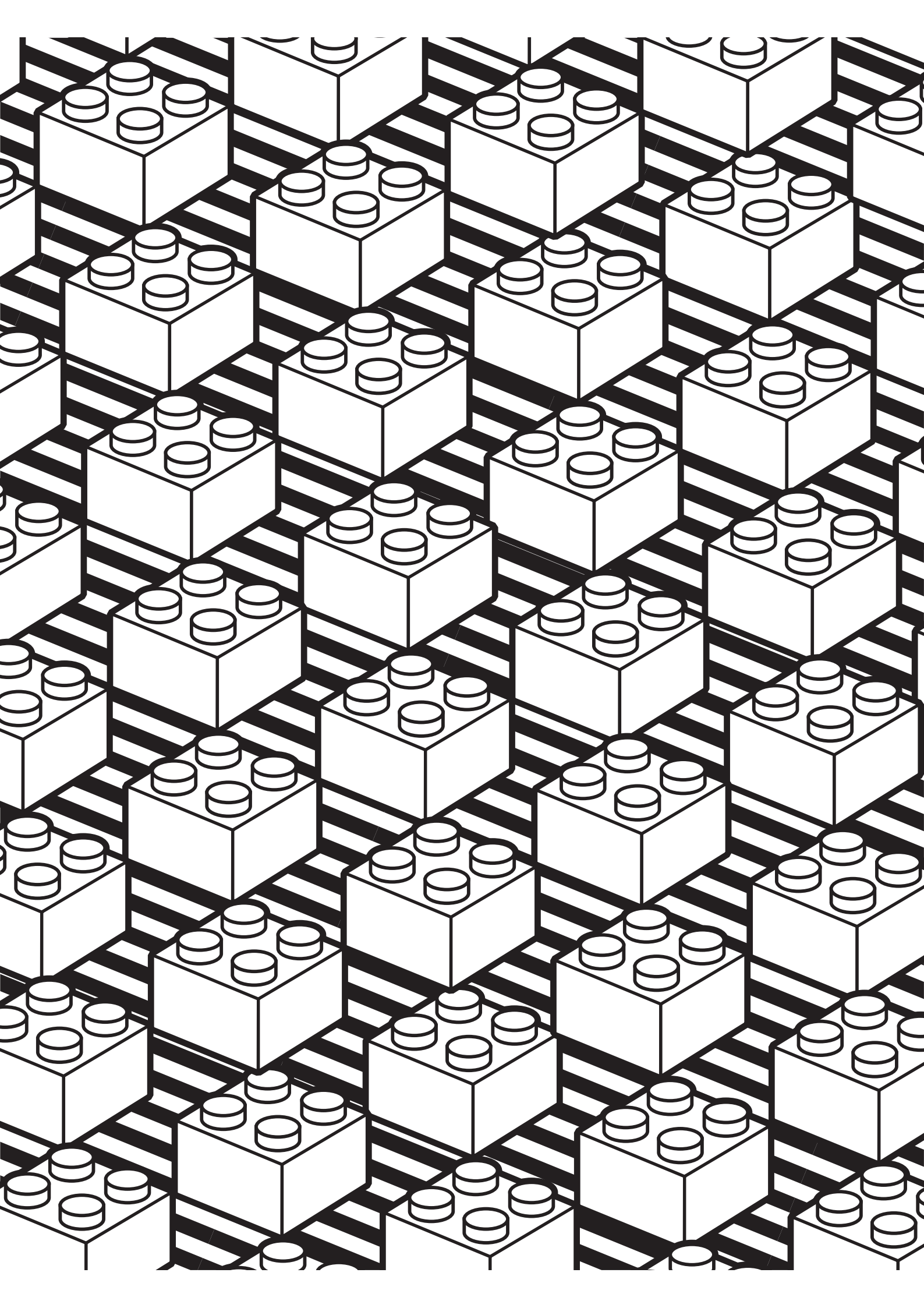

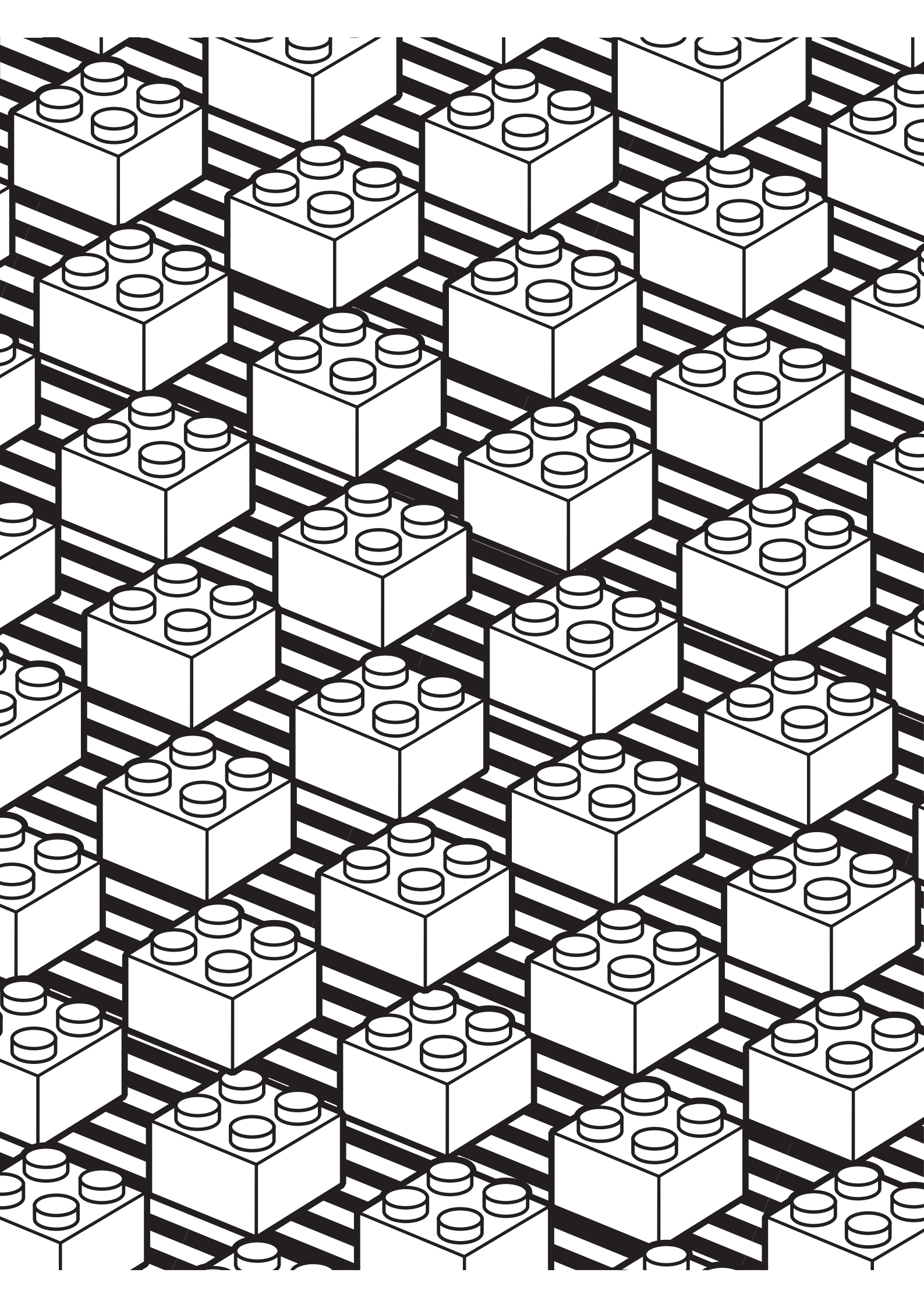

09

L'INVI-
SIBLE

niveau de difficulté : pour tous les voyants
et plus particulièrement pour Mme Irma, ma voisine

09

L'INVISIBLE

Niveau de difficulté : pour tous les voyants et plus particulièrement pour Mme Irma, ma voisine

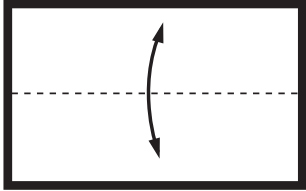

01

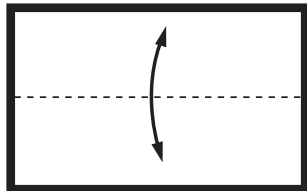

02

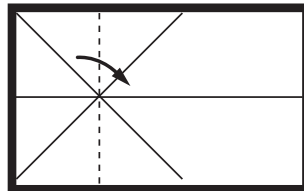

03

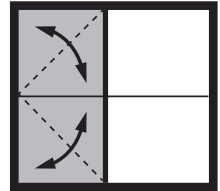

04

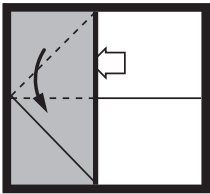

05

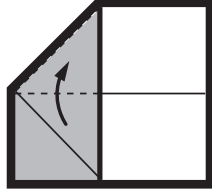

06

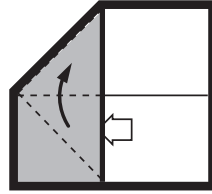

07

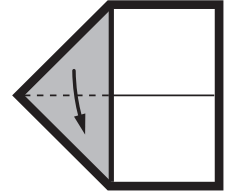

08

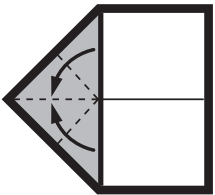

09

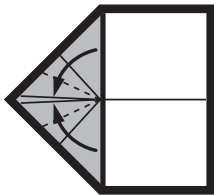

10

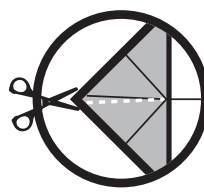

11

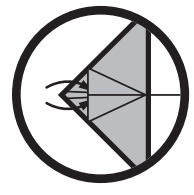

12

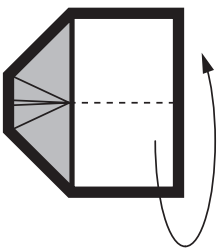

13

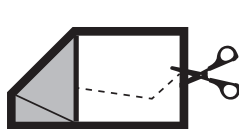

14

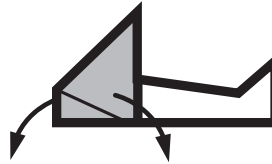

15

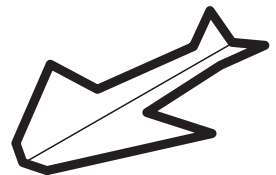

16

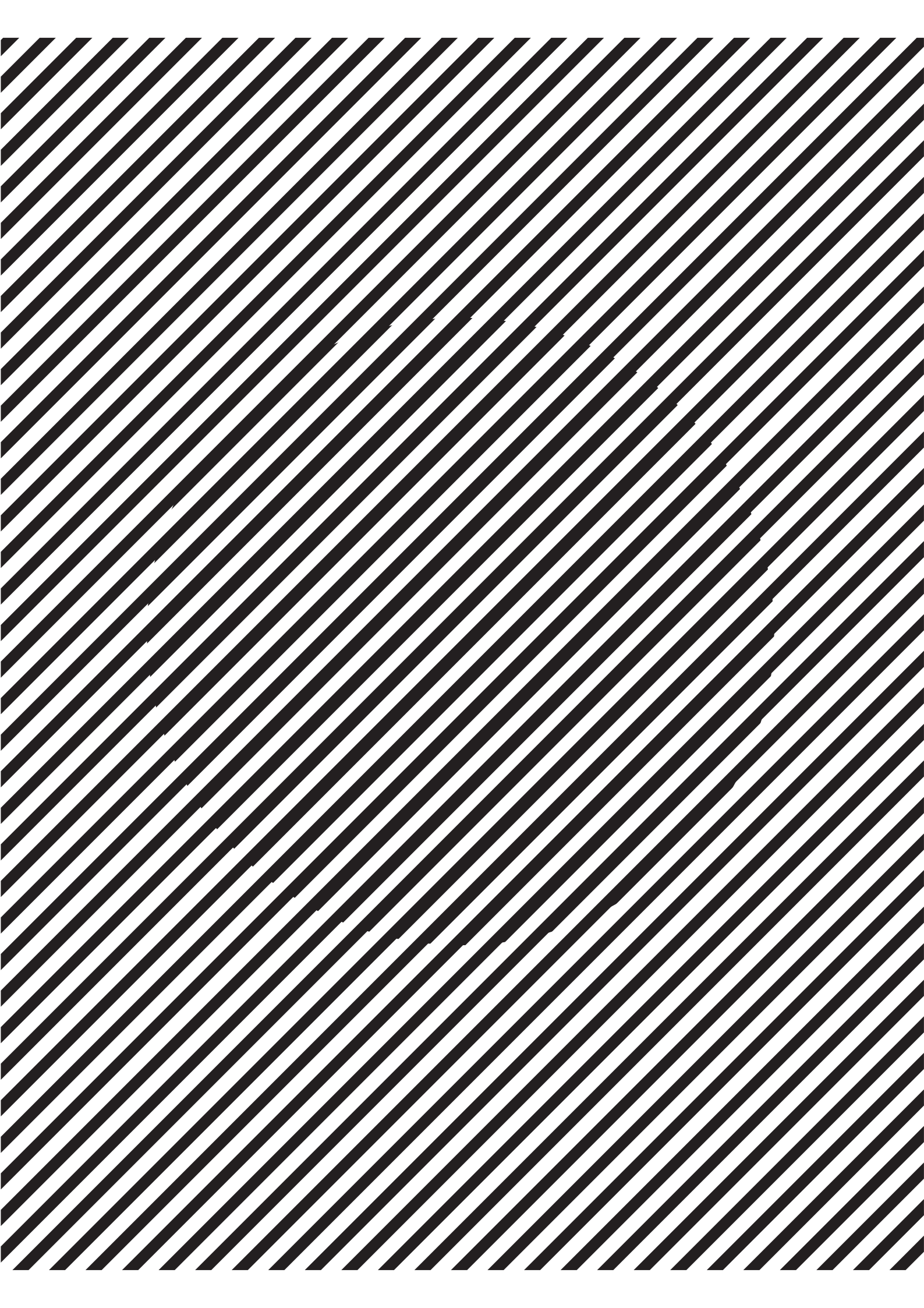

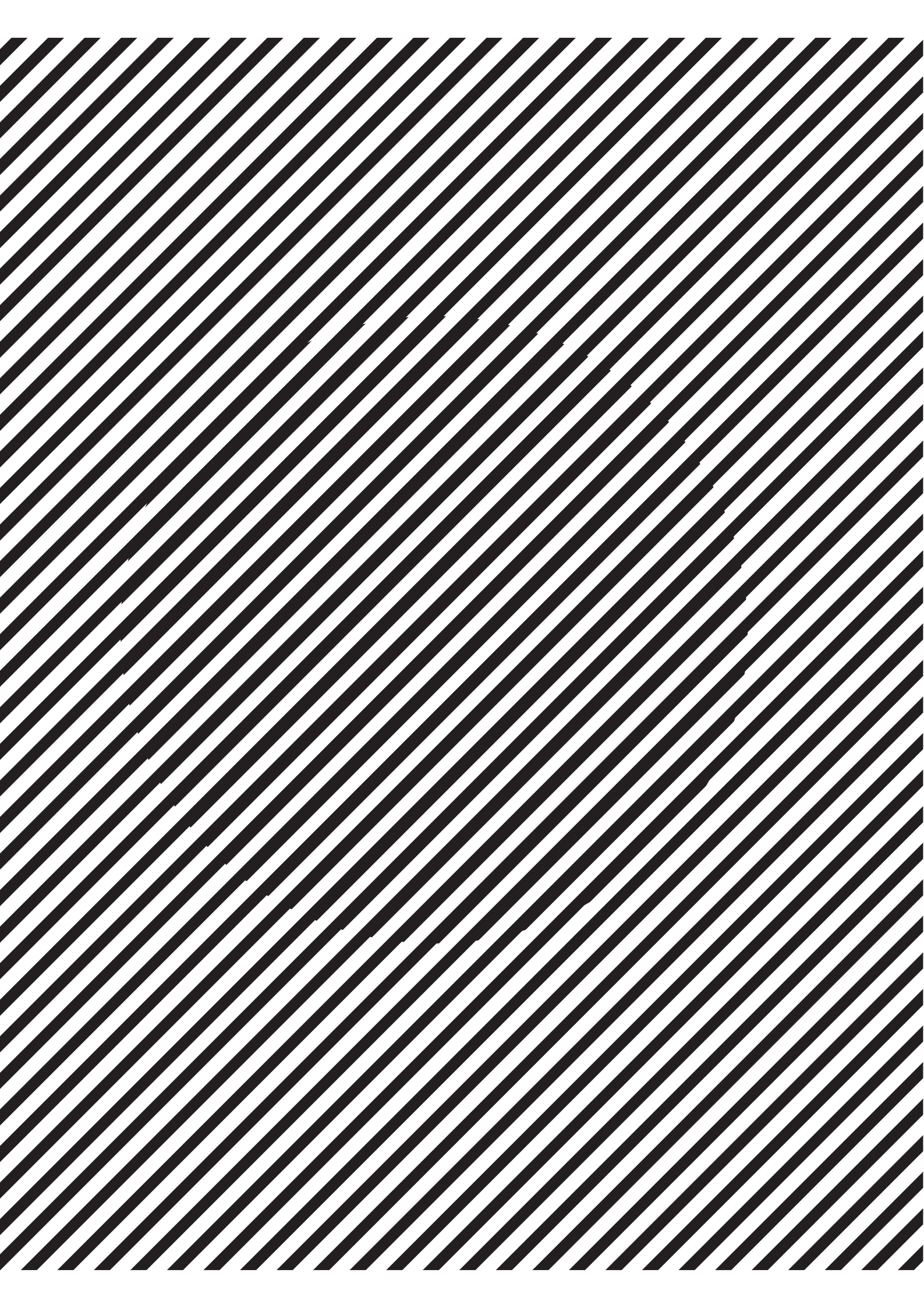

Revue unique et collector du VIP

NOT-

ICE

DE

PLA-

GE